



Grip Rail Couplings

Rapid clamping systems for transfer presses hydraulic, mechanical, electro- and hydro-mechanical version



Advantages

- Safe coupling and uncoupling in a few seconds
- Die positions are quickly and accurately reproducible
- High positioning accuracy of ± 0.02 mm
- Easy to retrofit
- No moving parts in the passive part, thus maintenance-free
- Self-locking
- High dynamic rigidity
- Flexible design of the energy couplings as per customer's specification

Application example



3-axis transfer system with hydraulic grip rail coupling (transfer rail coupling)

Application

- Automatic centring, coupling and clamping of grip rails on transfer presses
- The coupling is used whenever the maximum clamping force with high dynamic strength in the smallest space is required

Description

In contrast to conventional systems, the new coupling design is such that all components for positioning, centring and clamping force build-up as well as for position monitoring are integrated into the active part of the coupling which is firmly connected to the press. The passive part of the grip rail coupling does not have any moving parts.

To keep the weight of the coupling low, the housings of both the active and the passive parts are made from hard-coated, high-strength aluminium.

When moving the two halves of the coupling into position (insertion of grip rail), these are pre-centred by guide elements.

Positioning pins on the active part locate into drilled holes in the passive part, thereby centring the coupling and ensuring a high degree of reproducibility. By means of this type of centring a high repeatability is obtained.

The clamping force is built up using a tie rod and maintained in a self-locking manner.

A compact position monitoring system installed in the element is easily adaptable to a bus system and this ensures exact positioning and clamping.

As an option, rapid action couplings for energy, compressed air and hydraulic oil can be designed as per customer's specification.

Coupling - active part

The active part of the grip rail coupling is of a hydraulic, mechanical, electro- or hydro-mechanical design, depending on the required degree of automation.

Coupling - passive part

The passive counterpart is identical for the appropriate size.

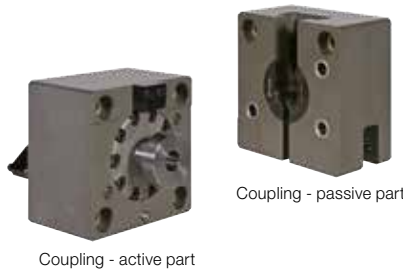

Coupling - active part

Coupling - passive part

Versions

Version GSH - hydraulic



Version GSM - mechanical



Version GSE - electro-mechanical



Version GSHM - hydro-mechanical

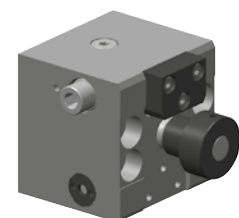

Grip rail couplings Version GSH - hydraulic



Description

After applying hydraulic pressure, the coupling halves are centred, clamping force is built up and the tie rod is mechanically locked.

Even in the event of a pressure drop the clamping force is fully maintained by mechanical self-locking.

For safety reasons, we recommend that the hydraulic pressure is maintained.

Technical data

Size		GSH 60	GSH 100
Clamping force	[kN]	60	100
Operating pressure	[bar]	60	60
A	[mm]	115	200
A1	[mm]	160	200
B	[mm]	100	120
C	[cm ³]	80	100
D	[cm ³]	95	84
E	[cm ³ /s]	–	175
Weight	[kg]	10,5	27
Centring repeatability	[mm]	± 0,02	± 0,02
Adm. horizontal positioning accuracy	[mm]	-1/+3	-1/+3
Adm. axis offset	[mm]	± 2	± 2

Further technical details on request or determined in the course of the project.

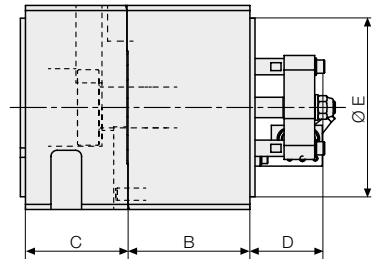
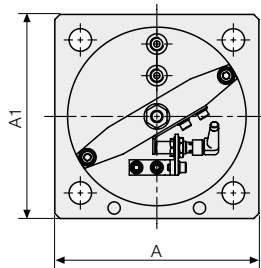

Fastening dimensions on request or according to customer's requirements

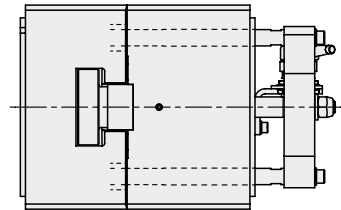

Possibilities of positioning and changing

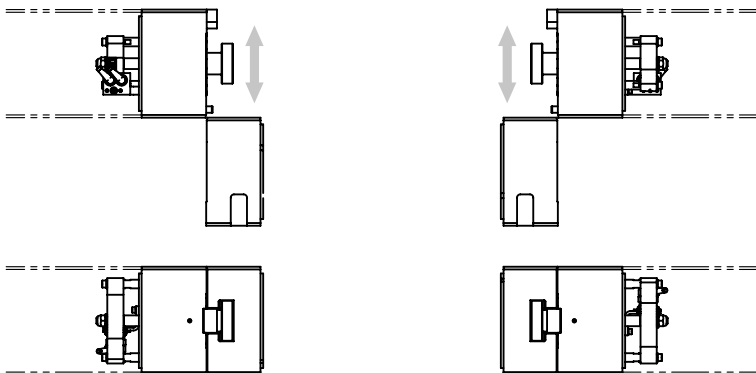

Grip rail couplings

Version GSM - mechanical



Description

By turning the hexagon socket the positioning pins are extended using a wedge system for centring the coupling halves, and the clamping force is built up. The self-locking wedge system, the high clamping forces and the high dynamic strength are the outstanding features of this clamping element.

Technical data

Size		GSM 60	GSM 100
Clamping force	[kN]	60	100
M_s	[Nm]	180	300
A	[mm]	115	200
A1	[mm]	160	200
B	[mm]	100	120
C	[cm³]	80	100
D	[cm³]	65	71
E	[cm³/s]	—	175
Weight	[kg]	12,5	29
Centring repeatability	[mm]	± 0,02	± 0,02
Adm. horizontal positioning accuracy	[mm]	-1/+3	-1/+3
Adm. axis offset	[mm]	± 2	± 2

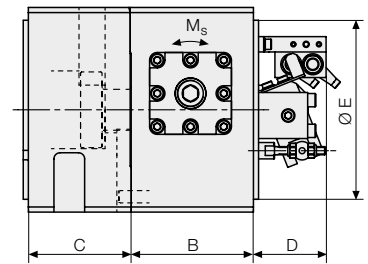
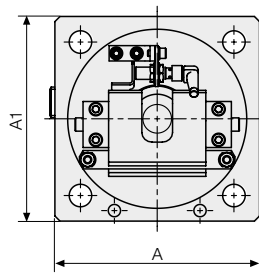

Fastening dimensions on request or according to customer's requirements

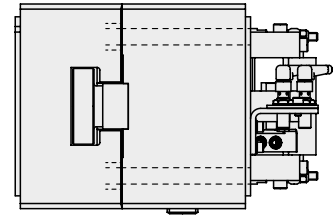

Further technical details on request or determined in the course of the project.

Possibilities of positioning and changing

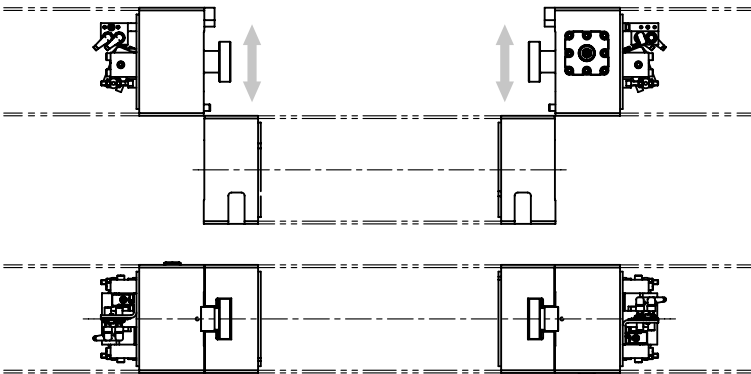

Grip rail couplings

Version GSE - electro-mechanical



Description

The rotary movement of the drive motor is transmitted to the tie rod and the positioning pins using a flex-spline gear and a spindle drive. The operating principle and the arrangement of the gear, position monitoring and automatic sequence of movement ensure high operational reliability.

Technical data

Size	GSE 100	
Clamping force	[kN]	100
Motor rating	[kW]	0,25
A	[mm]	200
A1	[mm]	200
B	[mm]	120
C	[cm ²]	100
D	[cm ²]	225
E	[cm ² /s]	175
Weight	[kg]	39
Centring repeatability	[mm]	± 0,02
Adm. horizontal positioning accuracy	[mm]	-1/+3
Adm. axis offset (mm)	[mm]	± 2

Further technical details on request or determined in the course of the project.

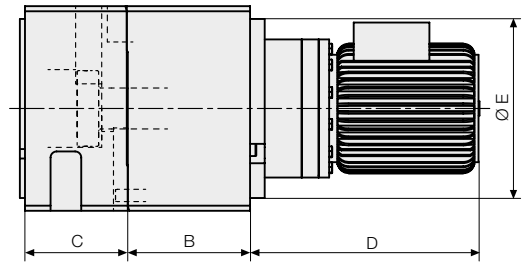
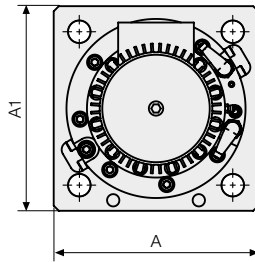

Fastening dimensions on request or according to customer's requirements

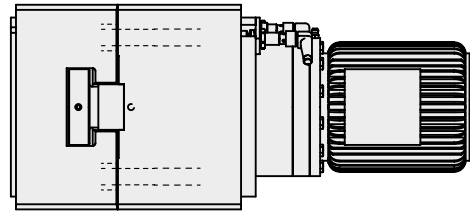

Possibilities of positioning and changing

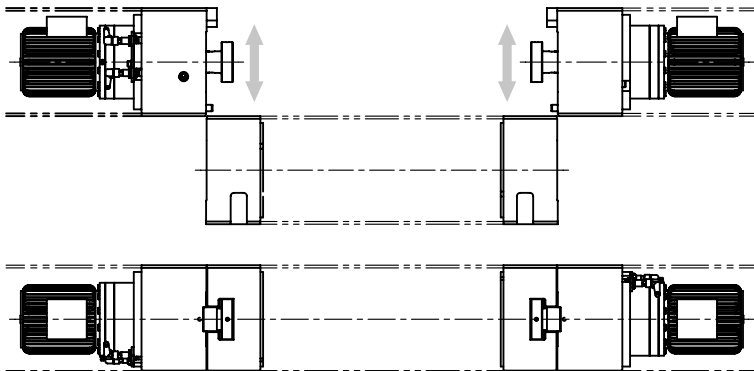

Grip rail couplings

Version GSHM - hydro-mechanical

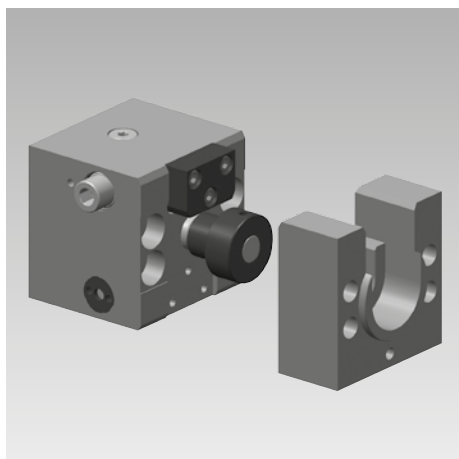

Description

By turning the hexagon socket the integral hydraulic pad is preloaded and transforms a low torque into a high clamping force. An indicator pin indicates that the clamping force has been reached.

Technical data

Size	GSHM 45	
Clamping force	[kN]	45
M_s	[Nm]	15
A	[mm]	80
A1	[mm]	80
B	[mm]	70
C	[cm ³]	37
Weight	[kg]	2
Centring repeatability	[mm]	± 0,15
Adm. horizontal positioning accuracy	[mm]	-1 / +2
Adm. axis offset (mm)	[mm]	± 2

Further technical details on request or determined in the course of the project.

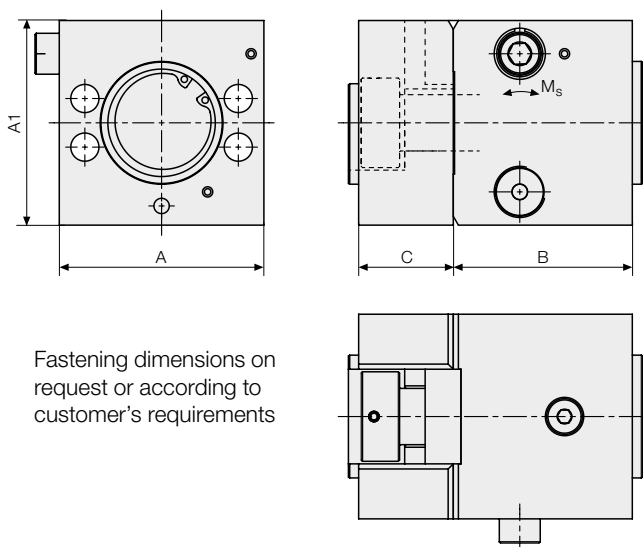

Fastening dimensions on request or according to customer's requirements